

可用于不带执行器的40°斜压。

检测

按动

滑动

旋转

编码器

电源

切换式

TACT Switch™

特别定做产品



主要规格

项目		规格
最大额定/最小额定(电阻负荷)		0,1A 12V DC/50μA 5V DC
电压下降值(初期/寿命后)		0.2V max/0.3V max
动作力		1±0.5N
动作寿命	无负载	300,000cycles
	负载	300,000cycles

产品一览

回路	接点数	切换时限	操作部形状	端子形状	主机形状	最小订货单位(pcs.)	产品编号	图号
1	1	Non shorting	Push	压入	无突起 L型	150	SPVQA10101	1
					无突起 R型		SPVQA10201	2

包装规格

散装

包装数 (pcs.)		出口包装箱尺寸 (mm)
1箱/日本	1箱/出口包装	
1,200	4,800	540×360×270

外形图

Unit:mm

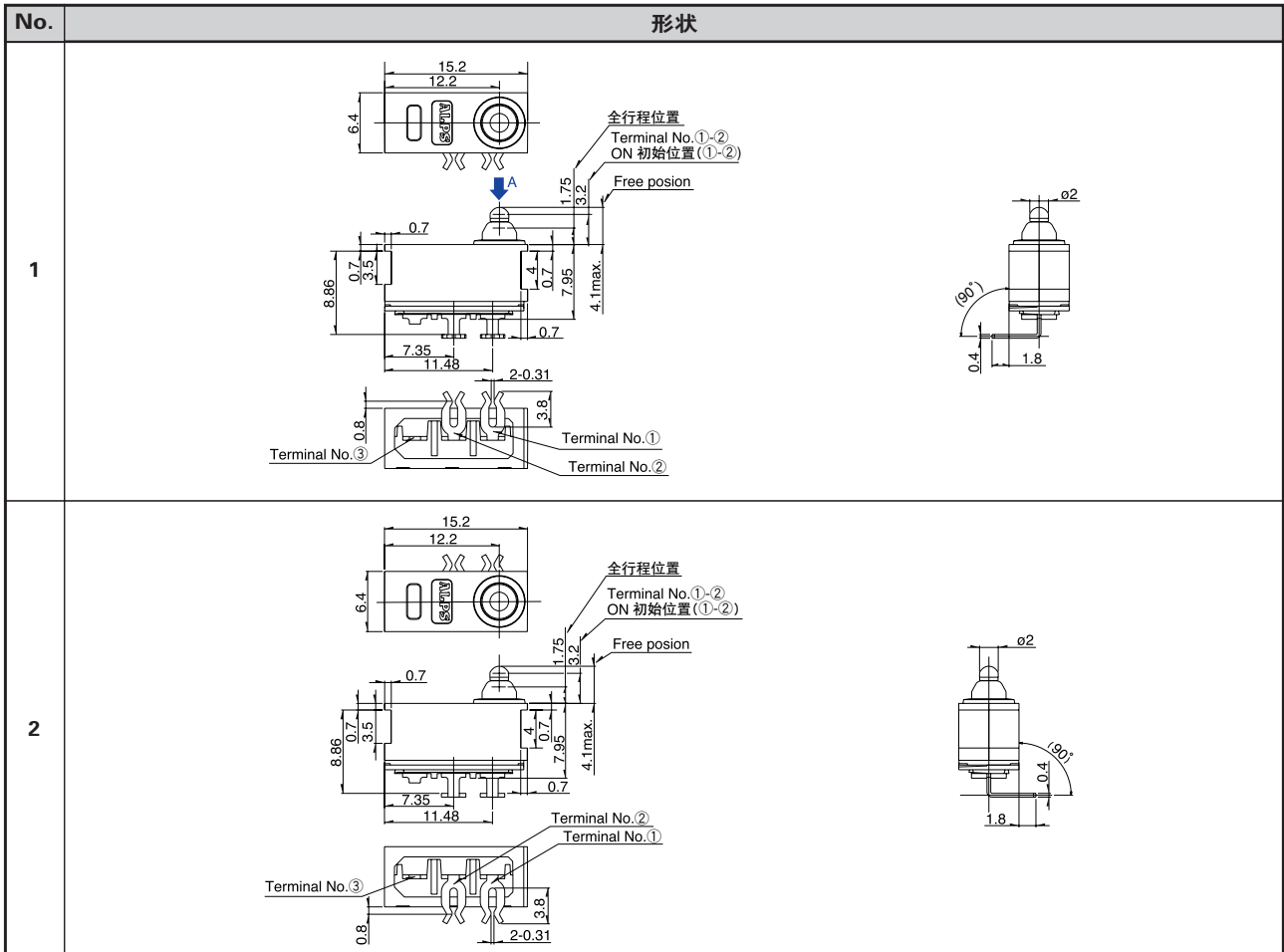

注

1. 本产品不能在水中使用。
2. 请以最小订购单位的N(整数)倍来订货。

■ 电路图

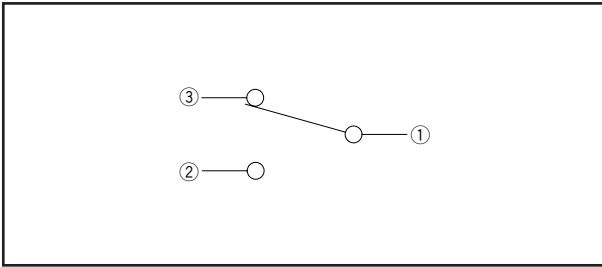

■ 端子形状

Unit:mm

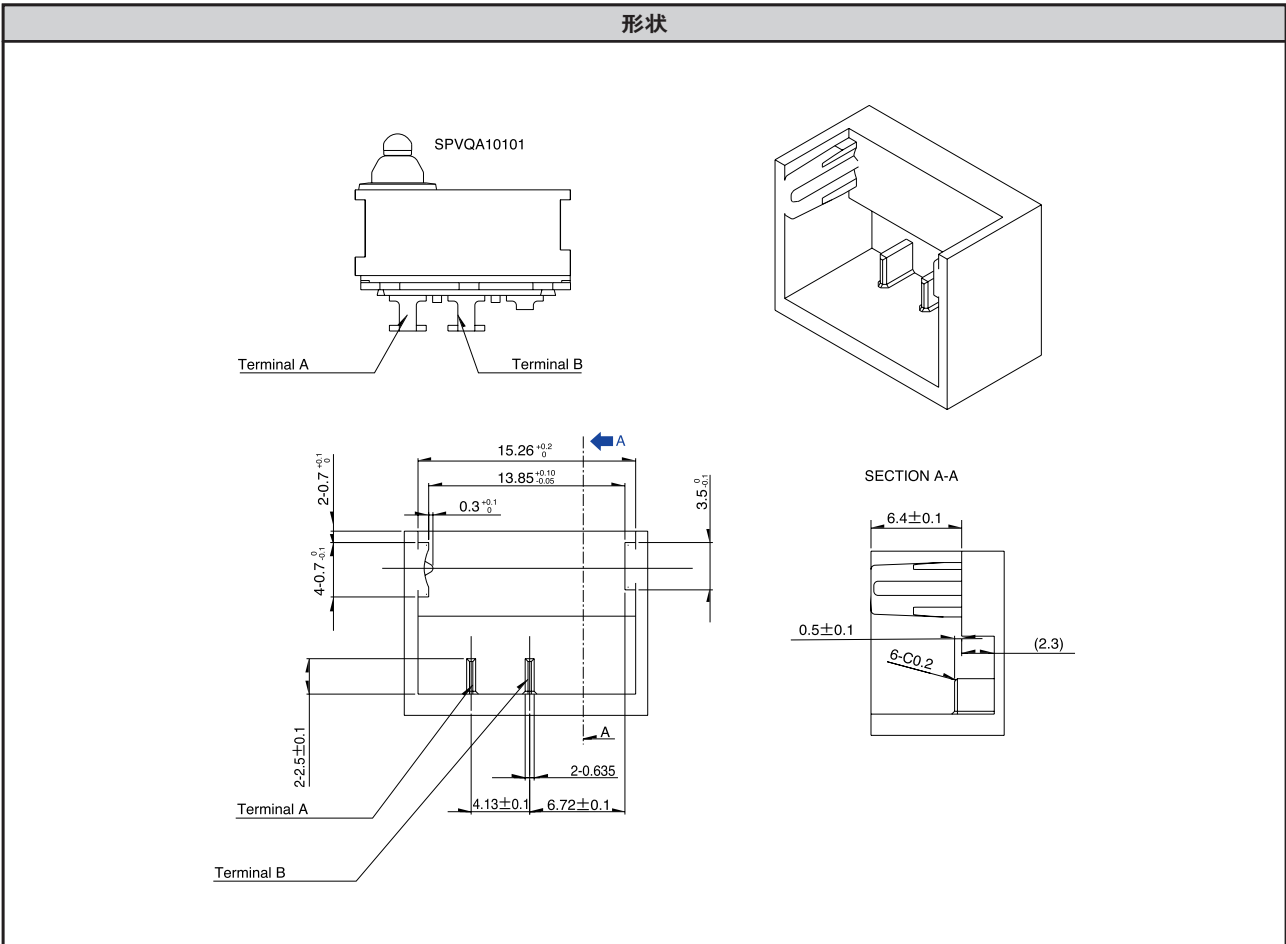

检测

按动

滑动

旋转

编码器













电源

切换式

TACT Switch™

特别定做  
产品

产品系列一览(通用型)

系列	防水型					电话机挂筒型	
	SPVQ4	SPVQ6	SPVQ7	SPVQA	SSCN	SPPY5	
照片							
动作形式							
使用温度范围	-40°C to +85°C					-10°C to +60°C	
车用产品	●	●	●	●	●	—	
最大额定 (电阻负荷)	0.1A 12V DC					50mA 48V DC max.	
最小额定 (电阻负荷)	50μA 3V DC	50μA 5V DC			100μA 3V DC		
电性能	初期接触电阻	500mΩ max.				100mΩ max.	
	绝缘电阻	100MΩ min. 500V DC					
	耐电压	500V AC for 1 minute					
机械性能	端子强度	3N for 1 minute				5N for 1 minute	
	操作部强度	20N			10N	5N	
耐久性	无负载寿命	300,000cycles 1Ω max.			100,000cycles 1Ω max.	300,000cycles 1Ω max.	
	负载寿命	(0.1A 12V DC) 300,000cycles 1Ω max.			(0.1A 12V DC) 100,000cycles 1Ω max.	(50mA 48V DC) 100,000cycles (100μA 3V DC) 300,000cycles	
耐环境性能	耐寒性能	-40±2°C for 500h				-20±2°C for 96h	
	耐热性能	85±2°C for 500h				85±2°C for 96h	
	耐湿性能	60±2°C, 90 to 95%RH for 500h				40±2°C, 90 to 95%RH for 96h	
外形尺寸 (mm)	W	14.7	13.3	14.7	15.2	13	14.4
	D	5.4	5.3	5.4	6.4	5	28.6
	H	7.6	7	6.7	7.95	25	7.15
焊接方法	手工焊接	300±10°C, 3 <sup>+1</sup> / <sub>0</sub> s			—	300±10°C, 3 <sup>+1</sup> / <sub>0</sub> s	350±5°C, 3s max.
	浸焊	260±5°C, 5±1s			—		
	回流焊接	—					请参照P.102
回路数	1					2	
动作力	1±0.3N	3N max.	1±0.5N		2N max.	0.8N max.	
页	92	93	95	97	99	100	

- 检测开关焊接条件 ..... 102
- 使用检测开关时的注意事项 ..... 103