

DM Series Miniature 2 Pole Power Rocker Switches



Features/Benefits

- 3 AMPS to 10 AMPS
- Quick connect terminals
- Double pole in miniature size
- Recessed bracket available—prevents accidental actuation
- RoHS compliant

Typical Applications

- Computers
- Appliances
- Electric tools

UL 61058-1



Specifications

CONTACT RATING:

DM21, DM22:

GP (general purpose)

3 AMPS 125 VAC 50/60 Hz T85 10,000 cycles

2 AMPS 250 VAC 50/60 Hz T85 10,000 cycles

R (resistive)

3 AMPS 30 VDC T85 10,000 cycles

DM61, DM62:

GP (general purpose)

10 AMPS 125 VAC 50/60 Hz T85 10,000 cycles

5 AMPS 250 VAC 50/60 Hz T85 10,000 cycles

R (resistive)

10 AMPS 30 VDC T85 10,000 cycles

ELECTRICAL LIFE: 10,000 make-and-break cycles at full load.

INSULATION RESISTANCE: $10^9 \Omega$ min.

DIELECTRIC STRENGTH: 1,000 Vrms min. @ sea level.

OPERATING TEMPERATURE: -20°C to +65°C

Materials

HOUSING & ACTUATOR: 6/6 nylon (UL94V-2), black.

MOVABLE CONTACTS: DM2X Models: Copper, silver plated.

DM6X Models: Coin silver, silver plated.

STATIONARY CONTACTS & TERMINALS: Copper or brass, silver plated.

CONTACT SPRING: Music wire or stainless steel.

NOTE: Any models supplied with Q contact material are RoHS compliant.

NOTE: Specifications and materials listed above are for standard switches. For information on specific and custom switches, consult Customer Service Center.

Build-A-Switch

To order, simply select desired option from each category and place in the appropriate box. Available options are shown and described on pages G-66 and G-69. For additional options not shown in catalog, consult Customer Service Center.

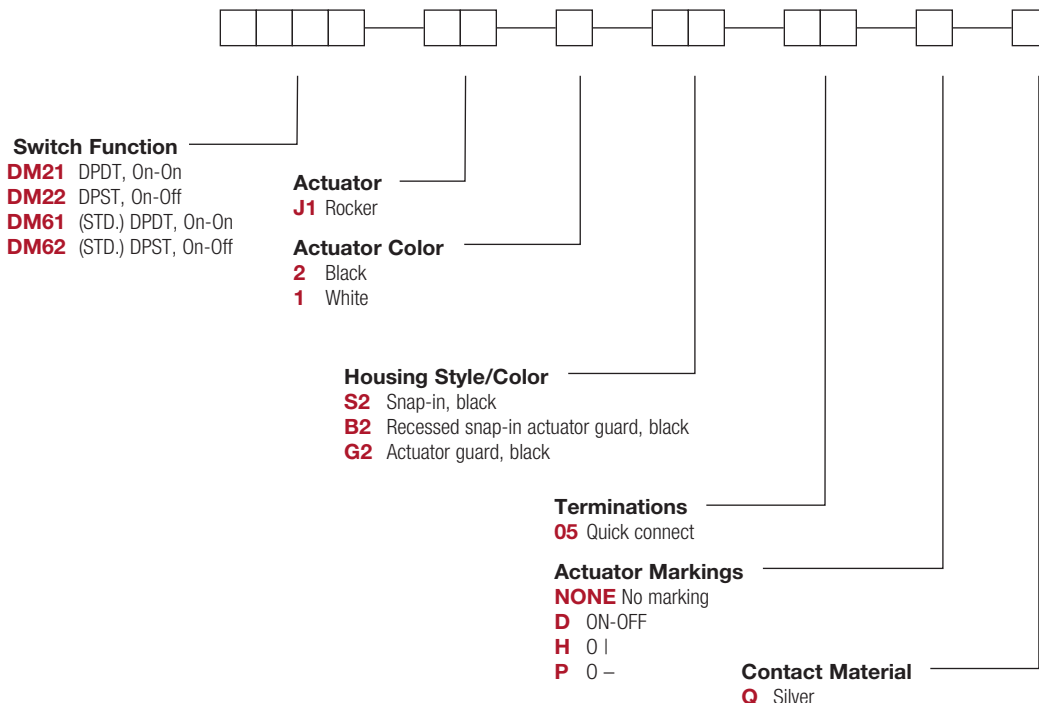

DM Series Miniature 2 Pole Power Rocker Switches

SWITCH FUNCTION



| NO. POLES | MODEL NO. | AMP RATING* | SWITCH FUNCTION | | CONNECTED TERMINALS | | SCHEMATIC |
|--|-------------|-------------|-----------------|--------|---------------------|------------|-----------|
| | | | POS. 1 | POS. 2 | POS. 1 | POS. 2 | |
| DP | DM22 | 3 | ON | OFF | 1-1A, 2-2A | OPEN | |
| | DM62 | 10 | ON | OFF | 1-1A, 2-2A | OPEN | |
| | DM21 | 3 | ON | ON | 1-1A, 2-2A | 1-1B, 2-2B | |
| | DM61 | 10 | ON | ON | 1-1A, 2-2A | 1-1B, 2-2B | |
| <p>DPDT</p> <p>PART NUMBER SHOWN: DM21J1XS205Q</p> <p>NOTES 1. ACTUATOR SHOWN IN POSITION 1-'ON' POSITION</p> | | | | | | | |

RATINGS: See page G-65 for complete ratings.



UL 61058-1 tested to 30C temperature rise @ 6,000 cycles.

ACTUATOR



J1 ROCKER

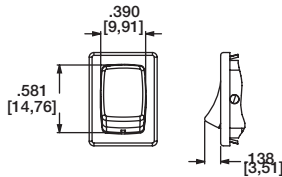

| OPTION CODE | ACTUATOR COLOR |
|-------------|----------------|
| 2 | BLACK |
| 1 | WHITE |

NOTE: Actuator finish: matte. Other colors available, consult Customer Service Center.

HOUSING STYLE/COLOR



S2 SNAP-IN, BLACK

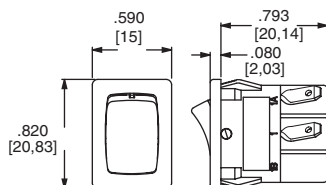

NOTE: Housing finish: matte. Other colors available, consult Customer Service Center.

B2 RECESSED SNAP-IN ACTUATOR GUARD, BLACK

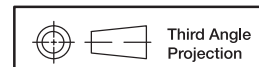
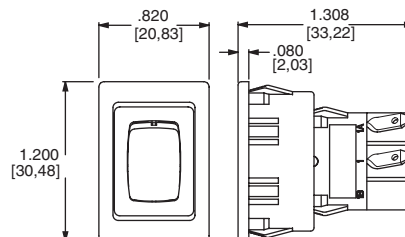

Dimensions are shown: Inches (mm)
Specifications and dimensions subject to change



15 May 20



DM Series Miniature 2 Pole Power Rocker Switches

HOUSING STYLE/COLOR

G2 ACTUATOR GUARD, BLACK

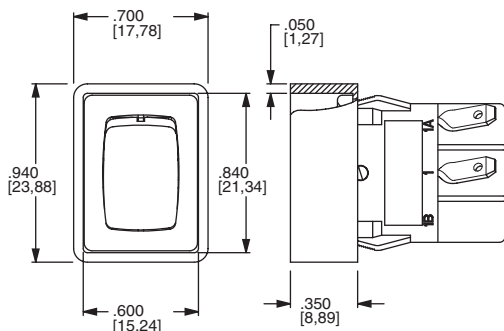

PANEL MOUNTING

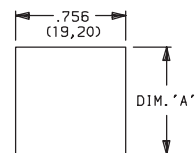
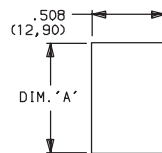

'S2' & 'G2' housing styles

'B2' housing style

NOTE: Blank insert available for SP models only, see page H-76.

| PANEL THICKNESS | DIM 'A' 'S2' & 'G2' HOUSING STYLES | DIM 'A' 'G2' OPTION SP MODELS ONLY | DIM 'A' 'B2' HOUSING STYLES |
|----------------------------|------------------------------------|------------------------------------|-----------------------------|
| .030-.049 (0,76) (1,24) | .756 (19,20) | 0.764 (19,41) | 1.068 (27,13) |
| .049-.079 (1,24) (2,01) | .764 (19,41) | 0.780 (19,81) | 1.076 (27,33) |
| .079-.118 (2,01) (3,00) | .780 (19,81) | n/a | 1.092 (27,74) |

TERMINATIONS

05 QUICK CONNECT

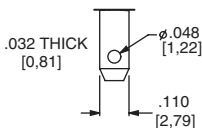

ACTUATOR MARKINGS

NONE NO MARKING

D ON-OFF

H O I

P O -

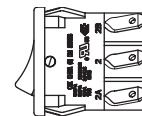
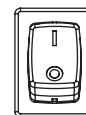

NOTE: Orientation of actuator markings and terminals.

'D' & 'P' marking options: marking color white, standard for all actuator colors except white actuators. Black marking color standard for white actuators. Consult Customer Service Center for other available marking colors.

CONTACT MATERIAL

| OPTION CODE | CONTACT AND TERMINAL MATERIAL | RATINGS | | |
|-------------|-------------------------------|-------------|---|--|
| Q | SILVER 1,2 | DM21, DM22: | GP (general purpose) | 3 AMPS 125 VAC 50/60 Hz T85 10,000 cycles |
| | | | R (resistive) | 2 AMPS 250 VAC 50/60 Hz T85 10,000 cycles |
| | | DM61, DM62: | GP (general purpose) | 3 AMPS 30 VDC T85 10,000 cycles |
| | | | R (resistive) | 10 AMPS 125 VAC 50/60 Hz T85 10,000 cycles |
| | | | 5 AMPS 250 VAC 50/60 Hz T85 10,000 cycles | |
| | | | 10 AMPS 30 VDC T85 10,000 cycles | |

* Note: See Technical Data section of this catalog for RoHS compliant and compatible definitions and specifications.

¹ MOVABLE CONTACT: DM2X Models: Copper, silver plated.
DM6X Models: Coin silver, silver plated.

² STATIONARY CONTACTS & TERMINALS: Copper or brass, silver plated.

NOTE: Any models supplied with Q contact material are RoHS compliant.

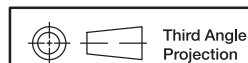

Dimensions are shown: Inches (mm)
Specifications and dimensions subject to change

Rocker

G

C&K

15 May 20

G-68

www.ckswitches.com

DM Series Miniature 2 Pole Power Rocker Switches

AVAILABLE HARDWARE

Insert

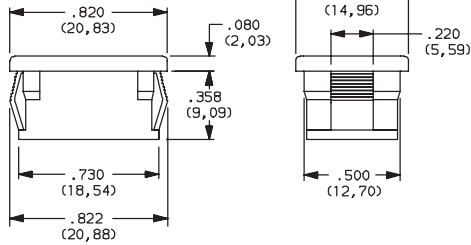

PART NO.
057190200

Material: Nylon 6/6
Finish: Matte

Recessed Actuator Guard



PART NO.
599D02000

Material: 6/6 Nylon
Finish: Matte

Actuator Guard



PART NO.
104C22000

Material: PBT thermoplastic
Finish: Matte

PART NO.
216C00000 IP54 SPLASH PROOF RUBBER BOOT

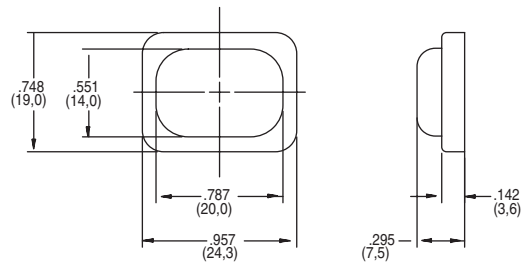

DM Series Miniature Illuminated Power Rocker Switches



Features/Benefits

- 3 AMPS to 10 AMPS
- Illuminated LED
- Positive detent
- RoHS compliant

Typical Applications

- Instrumentation
- Industrial
- Office machines



UL 61058-1

Specifications

CONTACT RATING:

DM14 and DM24 Models:

GP (general purpose)

3 AMPS @ 125 V AC; 2 AMPS @ 250 V AC.

R (resistive)

3 AMPS 30 VDC 10,000 cycles

DM54 and DM64 Models:

GP (general purpose)

10 AMPS @ 125 V AC; 5 AMPS @ 250 V AC (UL).

R (resistive)

10 AMPS 30 VDC 10,000 cycles

ELECTRICAL LIFE: 10,000 make-and-break cycles at full load.

INSULATION RESISTANCE: $10^9 \Omega$ min.

DIELECTRIC STRENGTH: 1,000 Vrms min. @ sea level.

Materials

HOUSING: 6/6 nylon (UL94V-2), black.

ACTUATOR: 6/6 nylon (UL94V-2), black.

MOVABLE CONTACTS: DM14 and DM24 Models: Copper, silver plated. DM54 and DM64 Models: Coin silver, silver plated.

STATIONARY CONTACTS & TERMINALS: Copper or brass, silver plated.

LED TERMINALS: Brass, unplated.

CONTACT SPRING: Music wire or stainless steel.

OPERATING TEMPERATURE: -20°C to +65°C

NOTE: Any models supplied with Q contact material are RoHS compliant.

NOTE: Specification and materials listed above are for standard switches. For information on specific and custom switches, consult Customer Service Center.

Build-A-Switch

To order, simply select desired option from each category and place in the appropriate box. Available options are shown and described on pages G-70 and G-73. For additional options not shown in catalog, consult Customer Service Center.

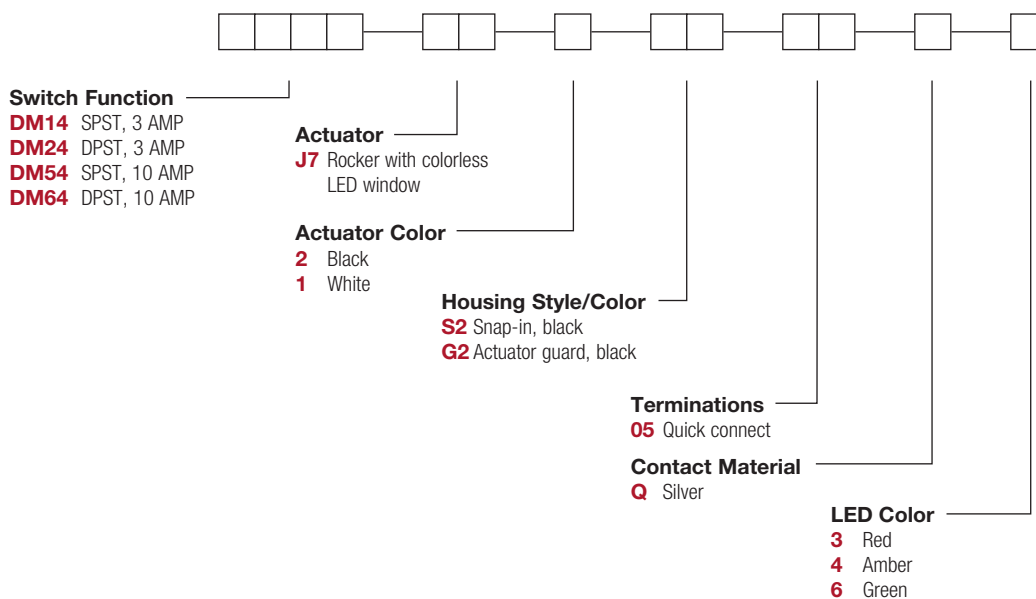

DM Series Miniature Illuminated Power Rocker Switches

SWITCH FUNCTION



| NO. POLES | MODEL NO. | AMP RATING* | SWITCH FUNCTION | | CONNECTED TERMINALS | | SCHEMATIC |
|-----------|-------------|-------------|-----------------|--------|---------------------|--------|-----------|
| | | | POS. 1 | POS. 2 | POS. 1 | POS. 2 | |
| SP | DM14 | 3 | ON | OFF | 1-1A | OPEN | |
| | DM54 | 10 | | | | | |
| DP | DM24 | 3 | ON | OFF | 1-1A, 2-2A | OPEN | |
| | DM64 | 10 | | | | | |

DPDT

Actuator shown in pos. 1 - 'ON' position.
SPST MODELS (DM14 & DM54) OMIT TERMINALS 2 & 2A.

Part number shown: DM24J72S205Q3

* RATINGS: see page G-69.



ACTUATOR



J7 ROCKER WITH COLORLESS LED WINDOW

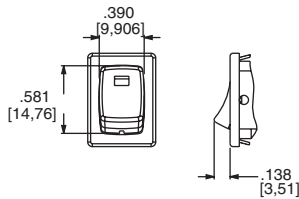

| OPTION CODE | ACTUATOR COLOR |
|-------------|----------------|
| 2 | BLACK |
| 1 | WHITE |

NOTE: Other colors available, consult Customer Service Center.

HOUSING STYLE/COLOR



S2 SNAP-IN, BLACK

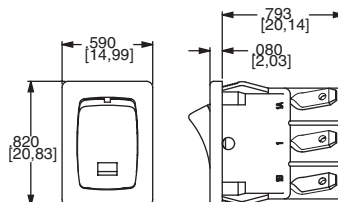

NOTE: Housing finish: matte. Other colors available, consult Customer Service Center.

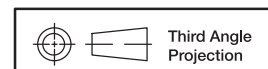

Dimensions are shown: Inches (mm)
Specifications and dimensions subject to change



15 May 20



DM Series Miniature Illuminated Power Rocker Switches

HOUSING STYLE/COLOR

G2 ACTUATOR GUARD, BLACK



PANEL MOUNTING

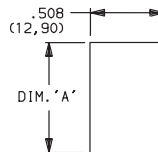

'S2' & 'G2' housing style

NOTE: Blank insert available for SP models only, see page H-80.

| PANEL THICKNESS | DIM 'A' 'S2' & 'G2' HOUSING STYLES | DIM 'A' with 'G2' option SP MODELS ONLY |
|----------------------------|------------------------------------|---|
| .030-.049 (0,76) (1,24) | 0.756 (19,20) | 0.764 (19,41) |
| .049-.079 (1,24) (2,01) | 0.764 (19,41) | 0.780 (19,81) |
| .079-.118 (2,01) (3,00) | .780 (19,81) | n/a |

TERMINATIONS

05 QUICK CONNECT

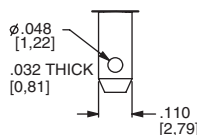

CONTACT MATERIAL

| OPTION CODE | CONTACT AND TERMINAL MATERIAL | RATINGS | | | |
|-------------|-------------------------------|---------|-------------|----------------------|--|
| | | POWER | | | |
| Q | SILVER 1,2 | POWER | DM14, DM24: | GP (general purpose) | 3 AMPS @ 125 V AC; 2 AMPS @ 250 V AC. |
| | | | | R (resistive) | 3 AMPS 30 VDC 10,000 cycles |
| | | | DM54, DM64: | GP (general purpose) | 10 AMPS @ 125 V AC; 5 AMPS @ 250 V AC. |
| | | | | R (resistive) | 10 AMPS 30 VDC 10,000 cycles |

* Note: See Technical Data section of this catalog for RoHS compliant and compatible definitions and specifications.

¹ MOVABLE CONTACTS: DM14 and DM24 models: Copper, silver plated.
DM54 and DM64 models: Coin silver, silver plated.

² STATIONARY CONTACTS & TERMINALS: Copper or brass, silver plated.

NOTE: Any models supplied with Q contact material are RoHS compliant.



LED COLOR

| OPTION CODE | LED COLOR | FORWARD V _{FD} | CURRENT I _{LED} | REVERSE V _R | INTENSITY M _{CD} | RECOMMENDED RESISTOR @ VOLTAGE | | |
|-------------|-----------|-------------------------|--------------------------|------------------------|---------------------------|--------------------------------|-----|------|
| | | | | | | 5V | 12V | 24V |
| 3 | Red | 2.1 | 10 | 4V | 1.6 typ. | 270 | 1K | 2.2K |
| 4 | Amber | 2.2 | 20 | 4V | 2.5 typ. | 150 | 510 | 1.2K |
| 6 | Green | 2.1 | 20 | 4V | 2.0 typ. | 150 | 510 | 1.2K |



Dimensions are shown: Inches (mm)
Specifications and dimensions subject to change

Rocker



15 May 20

DM Series Miniature Illuminated Power Rocker Switches

AVAILABLE HARDWARE

Blank Insert

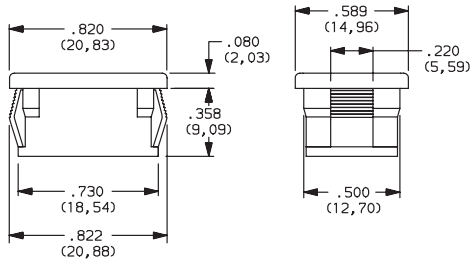

PART NO.
057190200

Material: Zinc nylon 6/6
Finish: Matte

Recessed Bracket

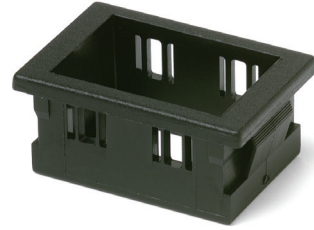

PART NO.
599D02000

Material: 6/6 Nylon
Finish: Matte

Actuator Guard

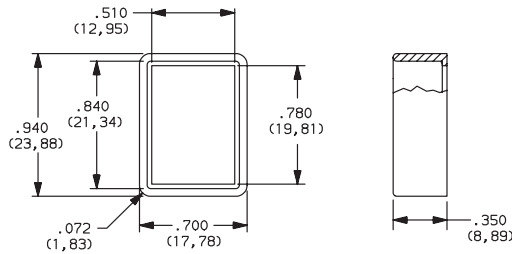

PART NO.
104C22000

Material: PBT thermoplastic
Finish: Matte

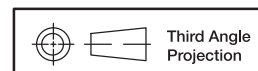

Dimensions are shown: Inches (mm)
Specifications and dimensions subject to change