

# SMD Power Inductor

## CD3015MB/DS



### 特点

- Ferrite core construction
- Low profile resin-shielded
- L×W×H: 3.2×3.2×1.5mm Max.
- Product weight: 0.052g (Ref.)
- Moisture Sensitivity Level: 1

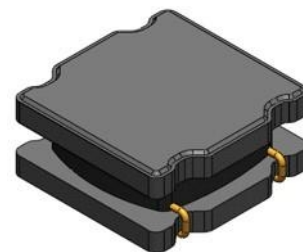

### 环境规格

- Operating temperature range: -40°C~+105°C (including coil's self temperature rise)
- Storage temperature range: -40°C~+105°C

### 包装

- Carrier tape and reel packaging
- 2000pcs per reel

### 用途

- DC/DC converter for CPU in notebook PC, smartphones, LCD displays, HDDs, DVDs, SSDs, DVCs, DSCs, PDAs etc.

### 外形尺寸 - [mm]

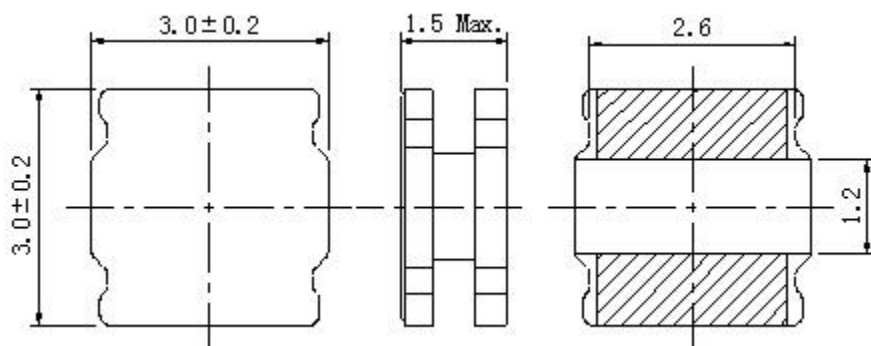

### 推荐焊盘尺寸 - [mm]

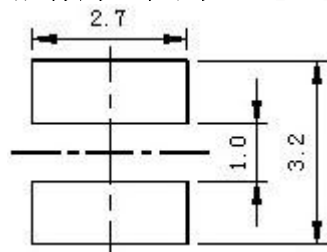

### 接线图 (底面)

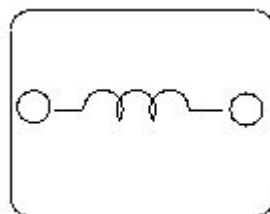

# SMD Power Inductor

## CD3015MB/DS



### 电气特性规格

品名	电感值 [within] ( $\mu$ H) ※1	直流电阻 (20°C) Max. (Typ.) (m $\Omega$ )	饱和电流 (A) Max. (Typ.) ※2	温度上升电流 (A) Max. (Typ.) ※3
CD3015MBDS-1R0NC	1.00	41.00 (34.00)	2.50 (2.90)	(2.60)
CD3015MBDS-1R5NC	1.50	52.00 (43.00)	1.90 (2.30)	(2.30)
CD3015MBDS-2R2MC	2.20	72.00 (60.00)	1.80 (2.10)	(2.00)
CD3015MBDS-4R7MC	4.70	155 (129)	1.30 (1.50)	(1.40)
CD3015MBDS-6R8MC	6.80	228 (190)	1.10 (1.30)	(1.10)
CD3015MBDS-100MC	10.00	321 (267)	0.81 (0.95)	(0.90)
CD3015MBDS-220MC	22.00	678 (565)	0.52 (0.62)	(0.65)
CD3015MBDS-330MC	33.00	1097 (914)	0.44 (0.52)	(0.50)

※1 Measuring frequency inductance at 100kHz 1V.

※2 Saturation current: This indicates the value of D.C. current when the inductance becomes 30% lower than its initial value.

※3 Temperature rise current: The actual value of D.C. current when the temperature of coil becomes  $\Delta T=40^{\circ}\text{C}$  ( $T_a=25^{\circ}\text{C}$ ).

### 回流焊耐热与推荐温度曲线图

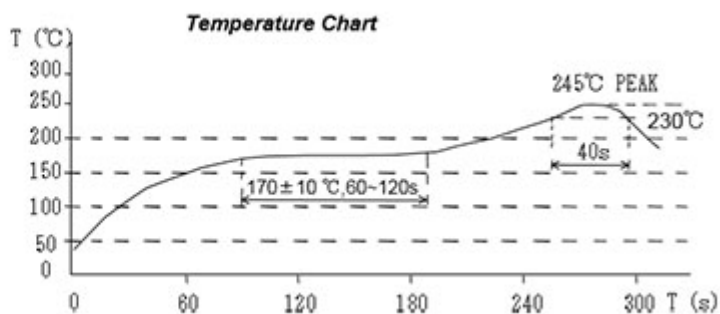
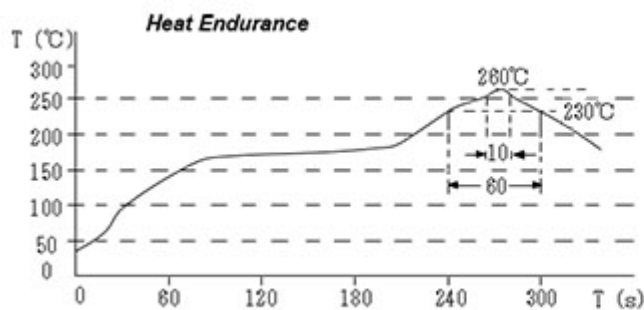

# SMD Power Inductor

## CD3015MB/DS



### 直流饱和电流&温度上升曲线图

1. CD3015MBDS-1R0NC

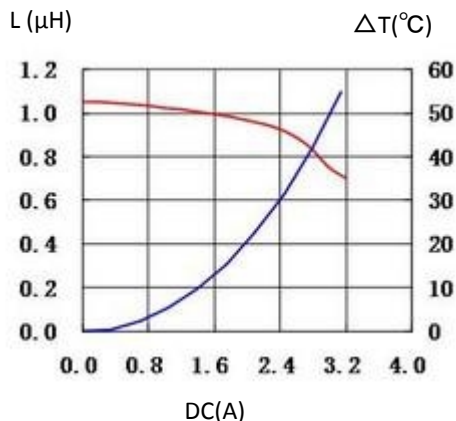

2. CD3015MBDS-1R5NC

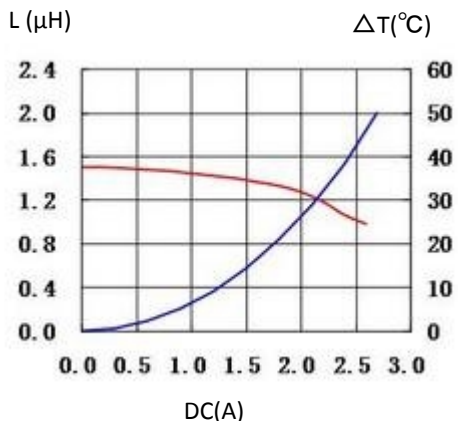

3. CD3015MBDS-2R2MC

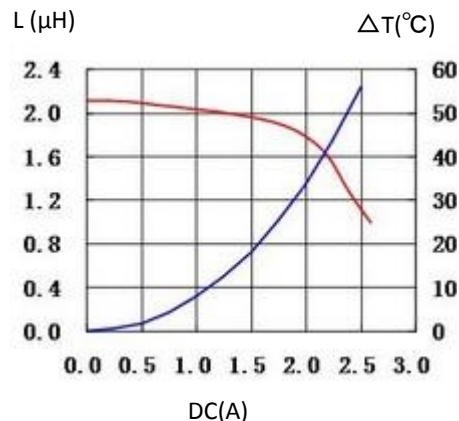

4. CD3015MBDS-4R7MC

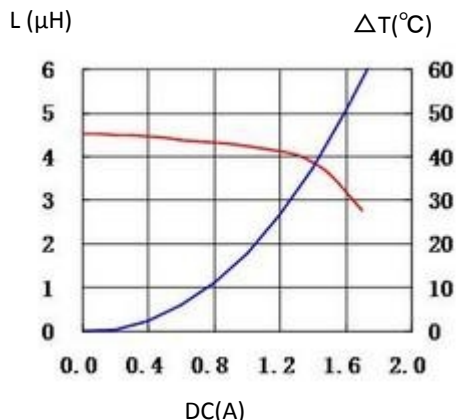

5. CD3015MBDS-6R8MC

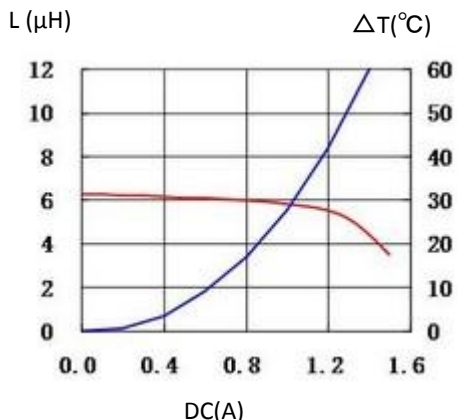

6. CD3015MBDS-100MC

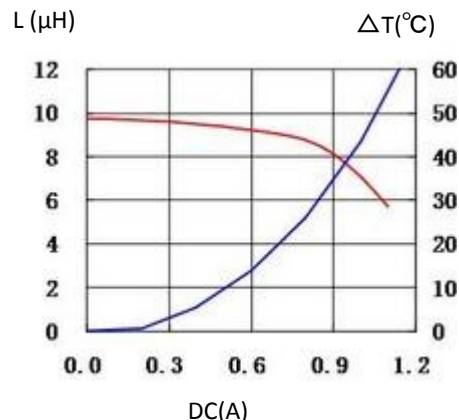

7. CD3015MBDS-220MC

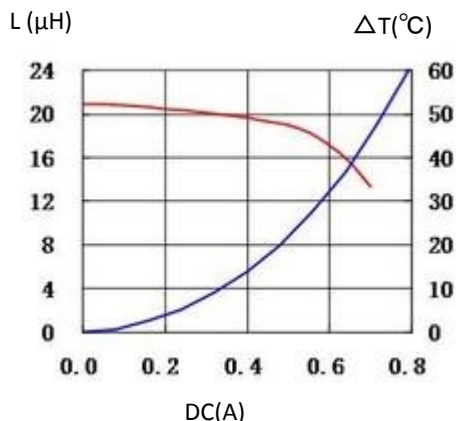

8. CD3015MBDS-330MC

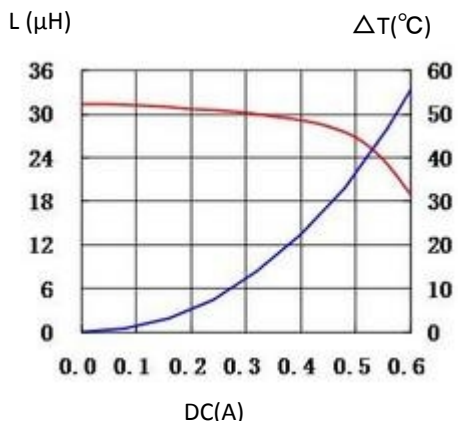

注：记载内容如有变更，恕不另行通知。订货时请联系您最近的销售办事处以获取最新产品信息。

# SMD Power Inductor

## CD3015MB/DS



有关销售办事处的信息，请 [点击这里](#)。